

2024 - 2025  
Architectural Interior Lighting

# MACRON

**VAL** | CYLINDER  
FAMILY

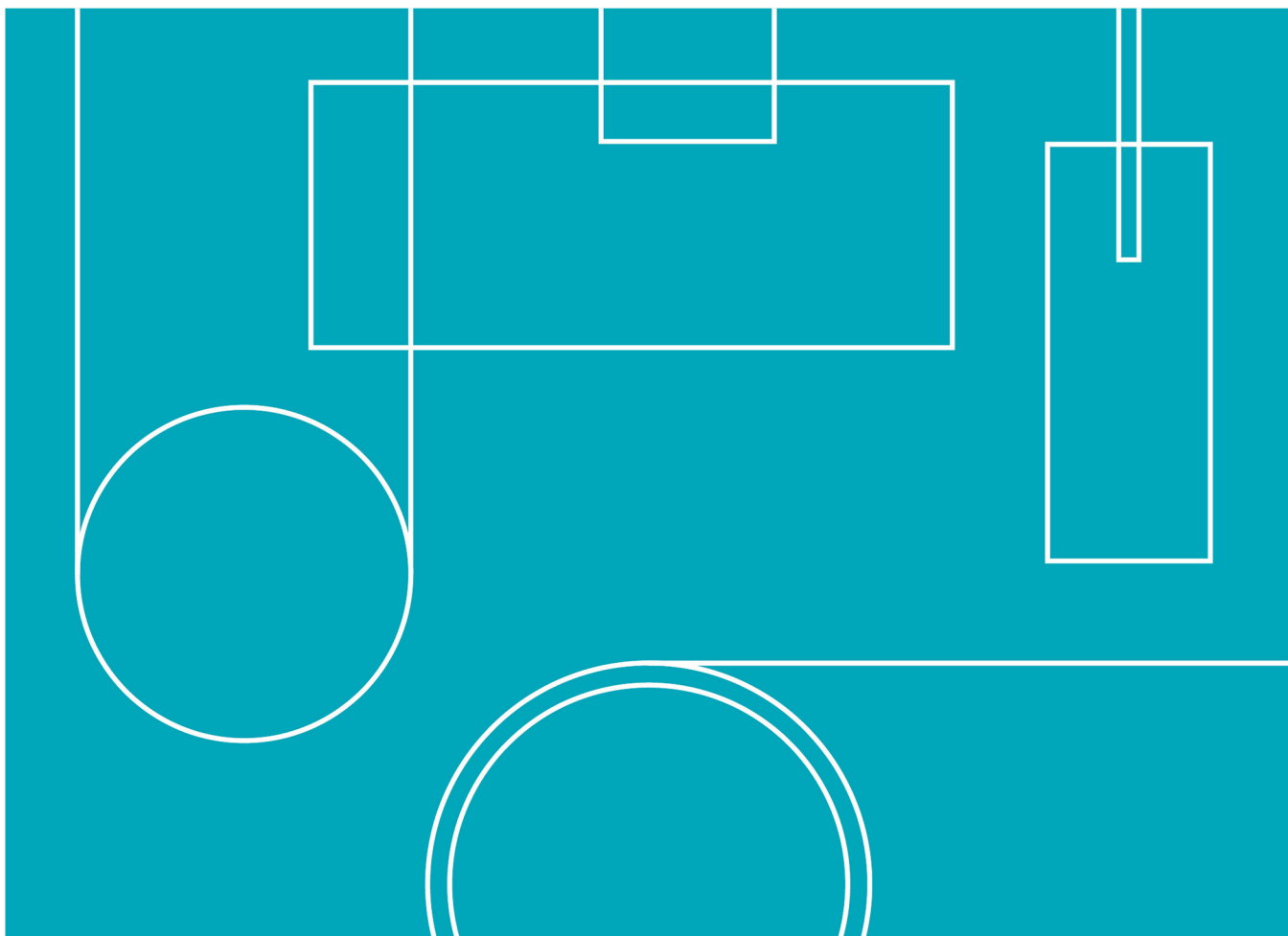

# Be The Light

Unluck infinite possibilities  
Redefine lines and shadow  
Fulfill design aspiration

## Elegance Redefined

---

VAL cylinder family redefines architectural lighting with intricate simplicity and aesthetic elegance. Its ultra-minimal look imparts stillness into the space and radiates characters that complete interior design. The concept of simplicity is highlighted from the aesthetic, installation, and visual features. VAL delivers unparalleled quality and exceptional lighting experience.

In the past years, VAL series has grown into a comprehensive collection of lighting instruments that bestow your space with functional elegance.



Surface

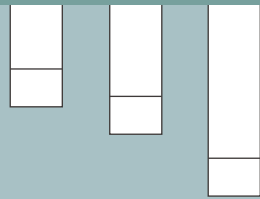

Surface Adjustable

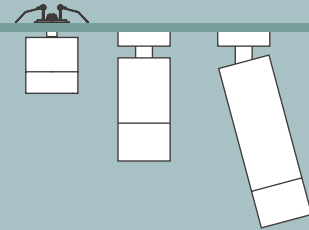

Cable Pendant

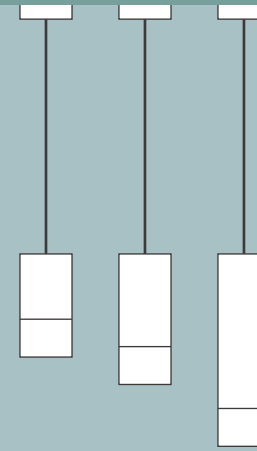

Stem Pendant

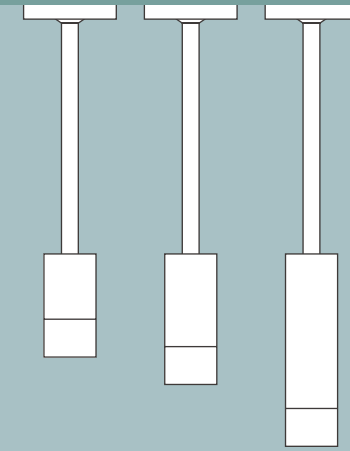

## VAL FEATURES

- 3 aperture sizes: 40 mm, 60 mm, and 90 mm
- 6 wattages: 10W, 12.5W, 15W, 18W, 25W, and 30W\*
- 3 body lengths per aperture
- 2 standard finishes
- 5 optical selections: Spot, medium, wide, flood, and wallwash\*\*
- 4 types of mounting applications\*\*\*
- 3-in-1 dimming protocol: TRIAC, ELV, and 0-10V
- 1 % dimming capability without flickering

\* Integrated driver in certain SKU's

\*\* Flood and wallwash available in VAL 55 and VAL 100

\*\*\* Track version is available in a separate catalog



Comprehensive  
Minimal  
Modular  
Playful

# Surface Cylinder Surface Adjustable



## VAL 25 Surface Cylinder

LENGTH | 200 / 300 / 400mm

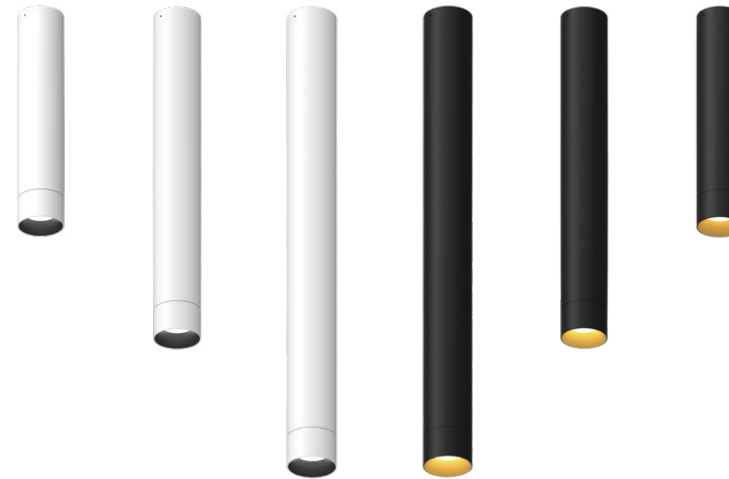

- Finish:
  - White / Black
  - Black / Gold
  - Black
- Optics:
  - 24° Spot
  - 34° Medium
  - 42° Wide
- Accessories:
  - Honeycomb Louver
  - Solite Lens
- Driver:
  - Integrated
- Decorative Element:
  - Clear decorative acrylic
- Power:
  - 10W

## VAL 55 Surface Cylinder

LENGTH | 100 / 150 / 200mm



- Finish:
  - White / Black
  - Black / Gold
  - Black
- Optics:
  - 22° Spot
  - 30° Medium
  - 40° Wide
  - 56° Flood
- Accessories:
  - Honeycomb Louver
  - Solite Lens
- Driver:
  - Integrated (200mm only)
- Decorative Element:
  - Clear decorative acrylic
- Power:
  - 9W(SSR10) / 14W(SSR15)
  - 16W(R20)

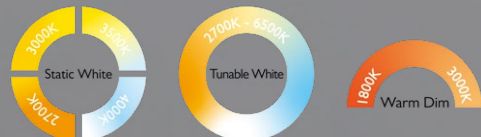

VAL 55 Surface Cylinder Wallwash

LENGTH | 100 / 200mm

Finish  White / Black Black

Optics  Wall Wash

Driver Integrated (200mm only)

Power 9W(SSR10) / 16W(R20)



VAL 55 Surface Adjustable

LENGTH | 100 / 200mm

Finish  White / Black Black / Gold Black

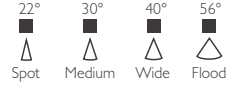
Optics  22° Spot 30° Medium 40° Wide 56° Flood

Accessories  Honeycomb Louver Solite Lens

Driver Integrated (200mm only)

Power 12.5W(SSR10) / 16W(R20)



VAL 100 Surface Cylinder

LENGTH | 100 / 150 / 200mm

Finish  White / Black Black / Gold Black

Optics  20° Spot 25° Medium 34° Wide 55° Flood

Accessories  Honeycomb Louver Solite Lens

Driver Integrated (150 / 200mm)

Decorative Element  Clear decorative acrylic

Power 18W(SSR10) / 21W(R15) 29W(R20)



VAL 100 Surface Adjustable

LENGTH | 100mm

Finish  White / Black Black / Gold Black

Optics  20° Spot 25° Medium 34° Wide 55° Flood

Accessories  Honeycomb Louver Solite Lens

Power 18W



# Cable Pendant Stem Pendant



MACRON PENDANT











VAL 25 Cable Pendant

LENGTH | 200 / 300 / 400mm

Finish	 White / Black  Black / Gold  Black
Optics	 24° Spot  34° Medium  42° Wide
Accessories	 Honeycomb Louver  Solite Lens
Driver	Integrated
Decorative Element	 Clear decorative acrylic
Power	10W

VAL 55 Cable Pendant

LENGTH | 100 / 150 / 200mm

Finish	 White / Black  Black / Gold  Black
Optics	 22° Spot  30° Medium  40° Wide  56° Flood  102° Up Flood
Accessories	 Honeycomb Louver  Solite Lens
Driver	Integrated (200mm only)
Decorative Element	 Clear decorative acrylic
Power	9W(SSR10) / 14W(SSR15) 16W(R20) / 21W(R20 CPRG)



VAL 55 Cable Pendant Wallwash

LENGTH | 100 / 200mm

Finish    
White / Black Black

Optics   
Wall Wash

Driver Integrated (200mm only)



Power 9W(SSR10) / 16W(R20)



VAL 25 Stem Pendant

LENGTH | 200 / 300 / 400mm

Finish     
White / Black Black / Gold Black

Optics     
24° Spot 34° Medium 42° Wide

Accessories    
Honeycomb Louver Solite Lens

Driver Integrated

Decorative Element   
Clear decorative acrylic



Power 10W



VAL 100 Cable Pendant

LENGTH | 100 / 150 / 200mm

Finish     
White / Black Black / Gold Black

Optics       
20° Spot 25° Medium 34° Wide 55° Flood 112° Up Flood

Accessories    
Honeycomb Louver Solite Lens

Driver Integrated (150 / 200mm)

Decorative Element   
Clear decorative acrylic





Power 18W(SSR10) / 21W(R15)  
29W(R20) / 34W(R20 CPRG)



VAL 55 Stem Pendant

LENGTH | 100 / 150 / 200mm

Finish     
White / Black Black / Gold Black

Optics       
22° Spot 30° Medium 40° Wide 56° Flood 102° Up Flood

Accessories    
Honeycomb Louver Solite Lens

Driver Integrated (200mm only)

Decorative Element   
Clear decorative acrylic

Power 9W(SSR10) / 14W(SSR15)  
16W(R20) / 21W(R20 CPRG)



VAL 100 Stem Pendant

LENGTH | 100 / 150 / 200mm

- Finish
  - White / Black
  - Black / Gold
  - Black
- Optics
  - 20° Spot
  - 25° Medium
  - 34° Wide
  - 55° Flood
  - 112° Up Flood
- Accessories
  - Honeycomb Louver
  - Solite Lens
- Driver
  - Integrated (150 / 200mm)
- Decorative Element
  - Clear decorative acrylic
- Power
  - 18W(SSR10) / 21W(R15)
  - 29W(R20) / 34W(R20 CPRG)



# Specification



VAL 25 Surface Cylinder

Light Distribution Curve: 200mm

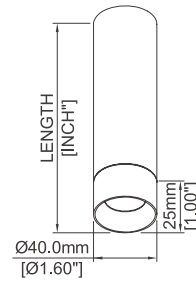
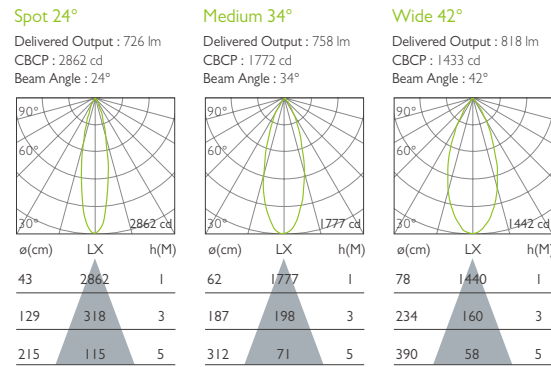

PRODUCT	TRIM STYLE	LENGTH	COLOR TEMPERATURE	FINISH	BEAM ANGLE	COLOR RENDERING	INPUT
VAL 25 CY	R Round	20 200mm 30 300mm 40 400mm	8.00° 12.0° 16.0°	27 2700 K 30 3000 K 35 3500 K 40 4000 K WD Warm Dim TW Tunable White	S Spot \ 24 deg. M Medium \ 34 deg. W Wide \ 42 deg.	9 90+ CRI	3AE 120-277V input, 0-10V/ TRIAC/ELV dimmable

VAL 100 Surface Cylinder

Light Distribution Curve: 200mm

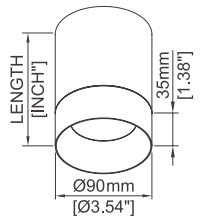
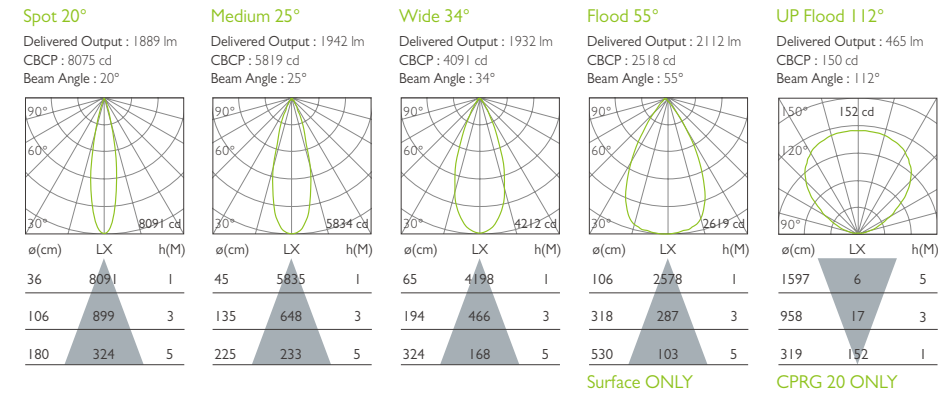

PRODUCT	TRIM STYLE	LENGTH	COLOR TEMPERATURE	FINISH	BEAM ANGLE	COLOR RENDERING	INPUT
VAL 100 CY SS	R Round	10 100mm 15 150mm 20 200mm	3.94° 5.90° 8.00°	27 2700 K 30 3000 K 35 3500 K 40 4000 K WD Warm Dim TW Tunable White	S Spot \ 20 deg. M Medium \ 25 deg. W Wide \ 34 deg. F Flood \ 55 deg. Up Floods \ 112 deg.	8 80+ CRI 9 90+ CRI	3AE 120-277V input, 0-10V/ TRIAC/ELV dimmable

VAL 55 Surface Cylinder / Surface Cylinder Wallwash

Light Distribution Curve: 200mm

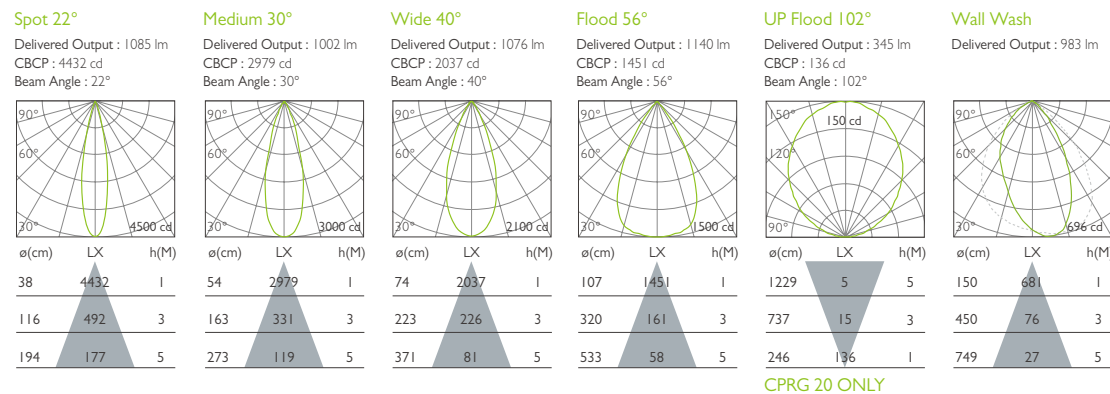

CPRG 20 ONLY

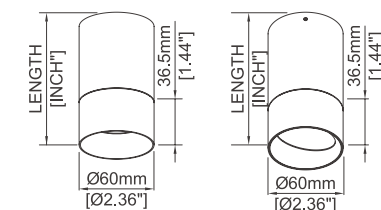

PRODUCT	TRIM STYLE	LENGTH	COLOR TEMPERATURE	FINISH	BEAM ANGLE	COLOR RENDERING	INPUT
VAL 55 CY SS	R Round	10 100mm 15 150mm	3.94° 5.90°	27 2700 K 30 3000 K 35 3500 K 40 4000 K WD Warm Dim TW Tunable White	S Spot \ 22 deg. M Medium \ 30 deg. W Wide \ 40 deg. F Flood \ 56 deg. Up Floods \ 102 deg.	8 80+ CRI 9 90+ CRI	3AE 120-277V input, 0-10V/ TRIAC/ELV dimmable
VAL 55 CY	R Round	20 200mm	8.00°	27 2700 K 30 3000 K 35 3500 K 40 4000 K WD Warm Dim TW Tunable White	S Spot \ 22 deg. M Medium \ 30 deg. W Wide \ 40 deg. F Flood \ 56 deg. Up Floods \ 102 deg.	8 80+ CRI 9 90+ CRI	3AE 120-277V input, 0-10V/ TRIAC/ELV dimmable

PRODUCT	TRIM STYLE	LENGTH	COLOR TEMPERATURE	FINISH	BEAM ANGLE	COLOR RENDERING	INPUT
VAL 55 CP WW SS	R Round	10 100mm	3.94°	27 2700 K 30 3000 K 35 3500 K 40 4000 K WD Warm Dim TW Tunable White	W (Wide)	8 80+ CRI 9 90+ CRI	3AE(200mm Only) 120-277V input, 0-10V/ TRIAC/ELV dimmable
VAL 55 CP WW	R Round	20 200mm	8.00°	27 2700 K 30 3000 K 35 3500 K 40 4000 K WD Warm Dim TW Tunable White	W (Wide)	8 80+ CRI 9 90+ CRI	3AE(200mm Only) 120-277V input, 0-10V/ TRIAC/ELV dimmable

VAL 55 Surface Adjustable

Light Distribution Curve: 100mm / 200mm

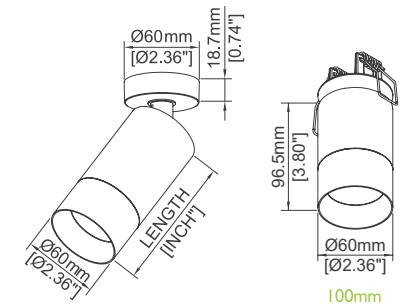
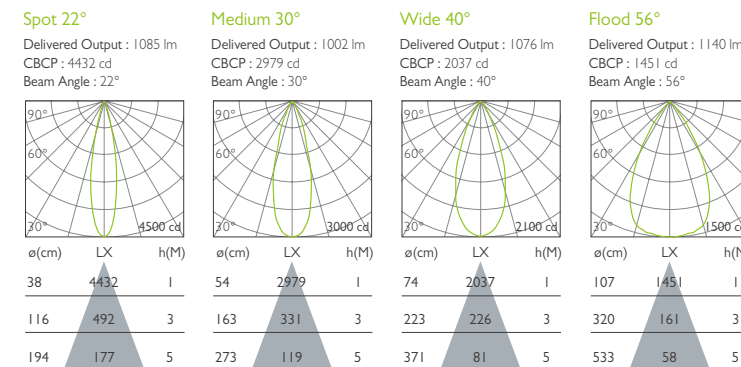

PRODUCT	TRIM STYLE	LENGTH	COLOR TEMPERATURE	FINISH	BEAM ANGLE	COLOR RENDERING	INPUT
VAL 55 CA RS	RS Recessed Spot	10 100mm	3.94°	27 2700 K 30 3000 K 35 3500 K 40 4000 K WD Warm Dim TW Tunable White	S Spot \ 22 deg. M Medium \ 30 deg. W Wide \ 40 deg. F Flood \ 56 deg.	8 80+ CRI 9 90+ CRI	3AE 120-277V input, 0-10V/ TRIAC/ELV dimmable
VAL 55 CA SS	R Round	10 100mm	3.94°	27 2700 K 30 3000 K 35 3500 K 40 4000 K WD Warm Dim TW Tunable White	S Spot \ 22 deg. M Medium \ 30 deg. W Wide \ 40 deg. F Flood \ 56 deg.	8 80+ CRI 9 90+ CRI	3AE 120-277V input, 0-10V/ TRIAC/ELV dimmable
VAL 55 CA	R Round	20 200mm	8.00°	27 2700 K 30 3000 K 35 3500 K 40 4000 K WD Warm Dim TW Tunable White	S Spot \ 22 deg. M Medium \ 30 deg. W Wide \ 40 deg. F Flood \ 56 deg.	8 80+ CRI 9 90+ CRI	3AE 120-277V input, 0-10V/ TRIAC/ELV dimmable

VAL 100 Surface Adjustable

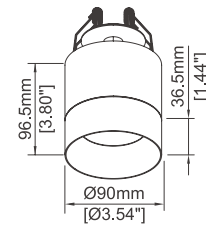
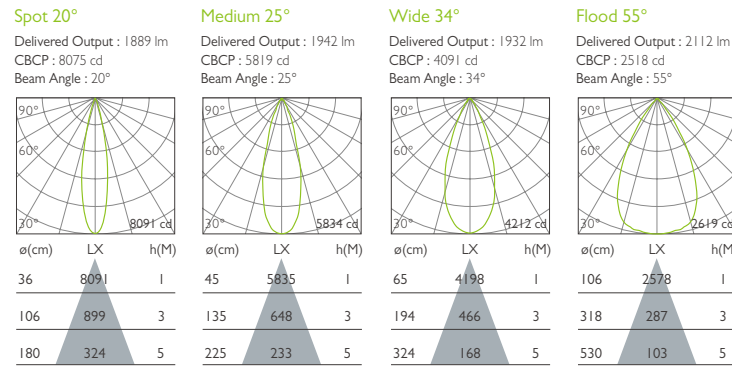

PRODUCT	TRIM STYLE	LENGTH	COLOR TEMPERATURE	FINISH	BEAM ANGLE	COLOR RENDERING
VAL 100 CA RS	R Round	10 100mm	27 2700 K 30 3000 K 35 3500 K 40 4000 K WD Warm Dim TW Tunable White	WHBK White \ Black BKGD Black \ Gold BKBK Black \ Black	S Spot \ 20 deg. M Medium \ 25 deg. W Wide \ 34 deg. F Flood \ 55 deg.	9 90+ CRI

VAL 25 Cable Pendant

Light Distribution Curve: 200mm

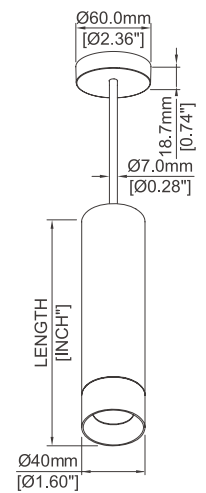
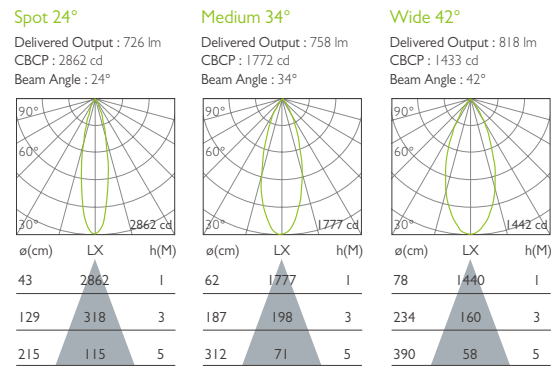

PRODUCT	TRIM STYLE	LENGTH	COLOR TEMPERATURE	FINISH	BEAM ANGLE	COLOR RENDERING	INPUT
VAL 25 CP	R Round	20 200mm 30 300mm 40 400mm	27 2700 K 30 3000 K 35 3500 K 40 4000 K WD Warm Dim TW Tunable White	WHBK White \ Black BKGD Black \ Gold BKBK Black \ Black	S Spot \ 24 deg. M Medium \ 34 deg. W Wide \ 42 deg.	9 90+ CRI	3AE 120-277V input, 0-10V/ TRIAC/ELV dimmable

VAL 55 Cable Pendant / Cable Pendant Wallwash

Light Distribution Curve: 200mm

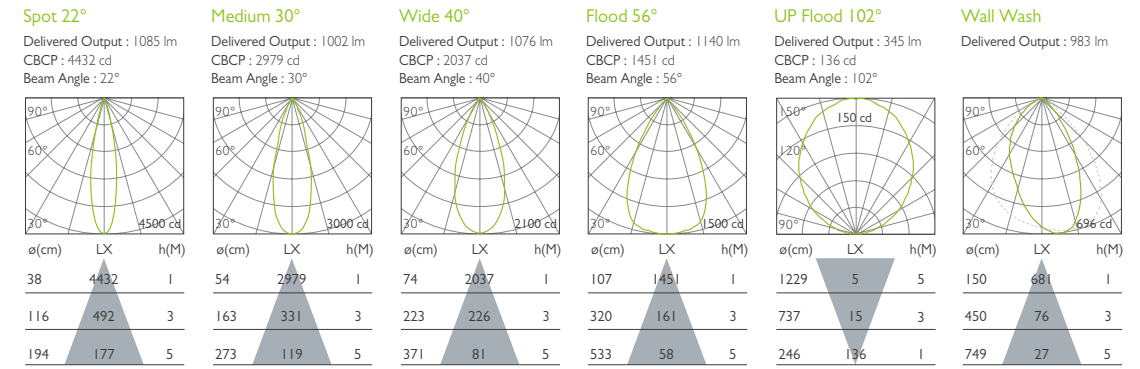

CPRG 20 ONLY

PRODUCT	TRIM STYLE	LENGTH	COLOR TEMPERATURE	FINISH	BEAM ANGLE	COLOR RENDERING	INPUT
VAL 55 CP SS	R Round	10 100mm 15 150mm	27 2700 K 30 3000 K 35 3500 K 40 4000 K	WHBK White \ Black BKGD Black \ Gold BKBK Black \ Black	S Spot \ 22 deg. M Medium \ 30 deg. W Wide \ 40 deg. F Flood \ 56 deg. Up Floors \ 102 deg.	8 80+ CRI 9 90+ CRI	3AE 120-277V input, 0-10V/ TRIAC/ELV dimmable
VAL 55 CP		20 200mm	8.00°	WD Warm Dim TW Tunable White			

PRODUCT	TRIM STYLE	LENGTH	COLOR TEMPERATURE	FINISH	BEAM ANGLE	COLOR RENDERING	INPUT
VAL 55 CP WW SS	R Round	10 100mm	27 2700 K 30 3000 K 35 3500 K 40 4000 K	WHBK White \ Black BKGD Black \ Black	W (Wide)	8 80+ CRI 9 90+ CRI	
VAL 55 CP WW		20 200mm	8.00°	WD Warm Dim TW Tunable White			3AE(200mm Only) 120-277V input, 0-10V/ TRIAC/ELV dimmable

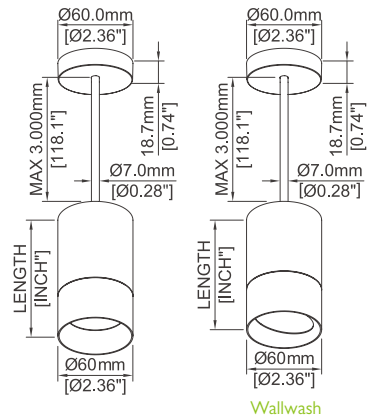

VAL 100 Cable Pendant

Light Distribution Curve: 200mm

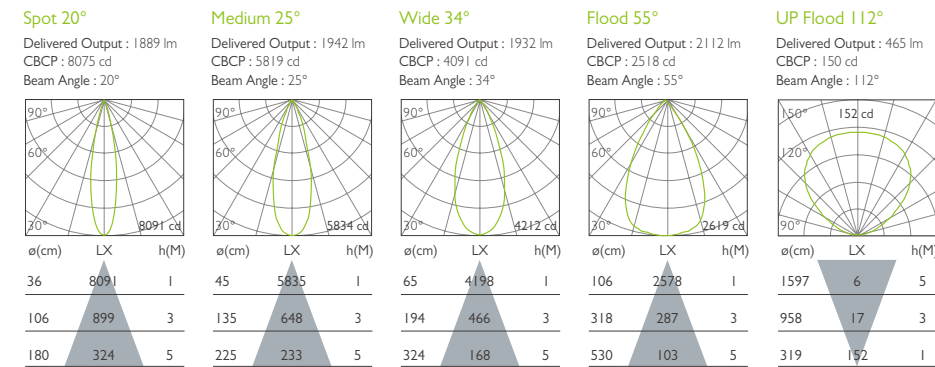

Surface ONLY

CPRG 20 ONLY

PRODUCT	TRIM STYLE	LENGTH	COLOR TEMPERATURE	FINISH	BEAM ANGLE	COLOR RENDERING	INPUT
VAL 100 CP SS	R Round	10 100mm	27 2700 K 30 3000 K 35 3500 K 40 4000 K	WHBK White \ Black BKGD Black \ Gold BKBK Black \ Black	S Spot \ 20 deg. M Medium \ 25 deg. W Wide \ 34 deg. F Flood \ 55 deg. Up Floors \ 112 deg.	8 80+ CRI 9 90+ CRI	
VAL 100 CP		15 150mm 20 200mm	5.90° 8.00°	WD Warm Dim TW Tunable White			3AE 120-277V input, 0-10V/ TRIAC/ELV dimmable

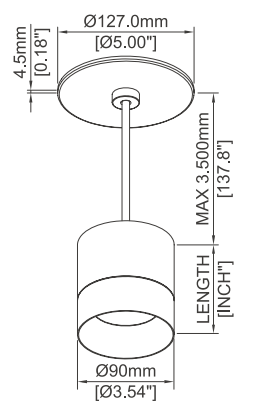

VAL 25 Stem Pendant

Light Distribution Curve: 200mm

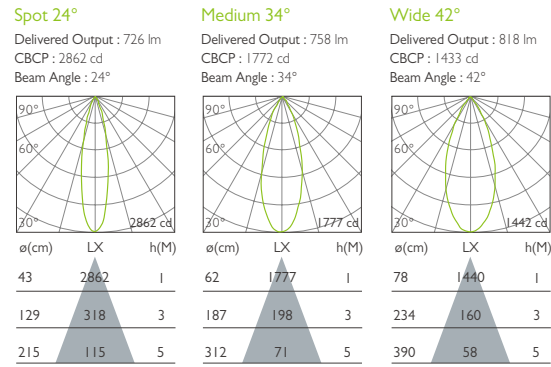

PRODUCT	TRIM STYLE	BODY LENGTH	STEM LENGTH	COLOR TEMPERATURE	FINISH	BEAM ANGLE	INPUT
VAL 25 CS	R Round	20 200mm 30 300mm 40 400mm	8.00" 12.0" 16.0"	60 (610 mm) 120 (1219 mm) 180 (1829 mm) CL Custom Length	WHBK White \ Black BKGD Black \ Gold BKBK Black \ Black	S Spot \ 24 deg. M Medium \ 34 deg. W Wide \ 42 deg.	3AE 120-277V input, 0-10V/ TRIAC/ELV dimmable

COLOR RENDERING	DECORATIVE ELEMENT
8 80+ CRI 9 90+ CRI	Standard Clear decorative acrylic Clear decorative acrylic, rose gold ring

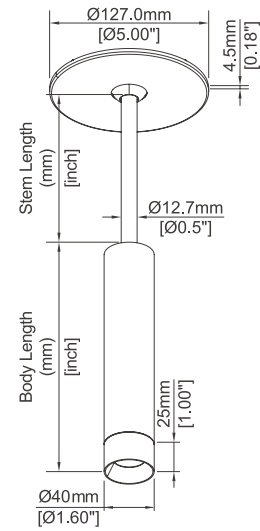

VAL 100 Stem Pendant

Light Distribution Curve: 200mm

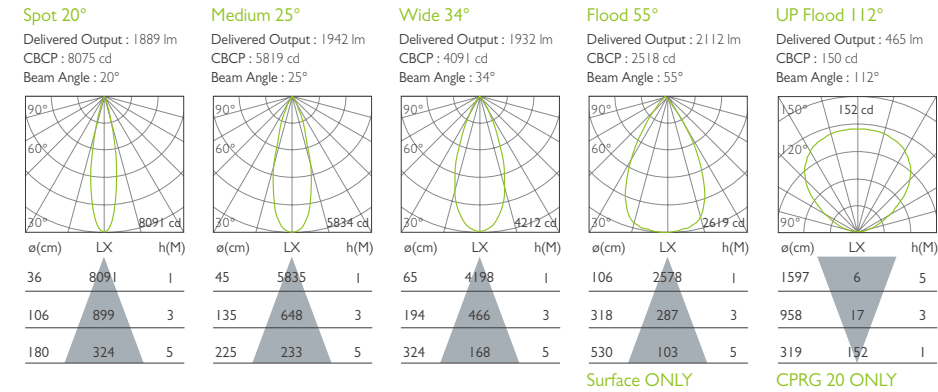

PRODUCT	TRIM STYLE	BODY LENGTH	STEM LENGTH	COLOR TEMPERATURE	FINISH	BEAM ANGLE	INPUT
VAL 100 CS SS	R Round	10 100mm 15 150mm 20 200mm	3.94" 5.90" 8.00"	60 (610 mm) 120 (1219 mm) 180 (1829 mm) CL Custom Length	WHBK White \ Black BKGD Black \ Gold BKBK Black \ Black	Spot \ 20 deg. Medium \ 25 deg. Wide \ 34 deg. Flood \ 55 deg. Up Flood \ 112 deg.	3AE 120-277V input, 0-10V/ TRIAC/ELV dimmable

COLOR RENDERING	DECORATIVE ELEMENT
8 80+ CRI 9 90+ CRI	Standard Clear decorative acrylic Clear decorative acrylic, rose gold ring

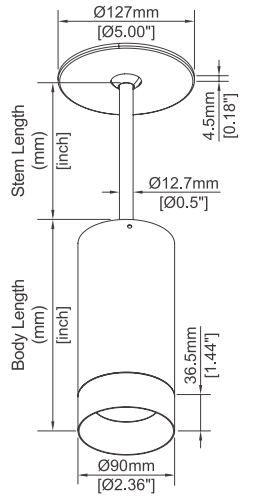

VAL 55 Stem Pendant

Light Distribution Curve: 200mm

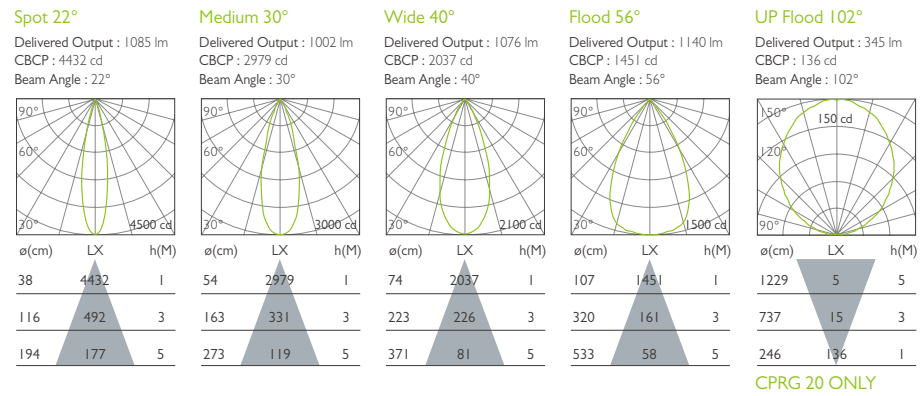

PRODUCT	TRIM STYLE	BODY LENGTH	STEM LENGTH	COLOR TEMPERATURE	FINISH	BEAM ANGLE	INPUT
VAL 55 CS SS	R Round	10 100mm 15 150mm	3.94" 5.90"	60 (610 mm) 120 (1219 mm) 180 (1829 mm) CL Custom Length	WHBK White \ Black BKGD Black \ Gold BKBK Black \ Black	Spot \ 22 deg. Medium \ 30 deg. Wide \ 40 deg. Flood \ 56 deg. Up Floods \ 102 deg.	3AE 120-277V input, 0-10V/ TRIAC/ELV dimmable
VAL 55 CS		20 200mm	8.00"		WD Warm Dim TW Tunable White		

COLOR RENDERING	DECORATIVE ELEMENT
8 80+ CRI 9 90+ CRI	Standard Clear decorative acrylic Clear decorative acrylic, rose gold ring

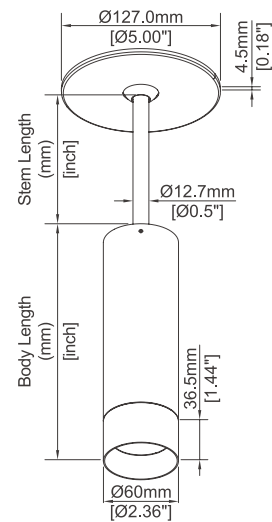

# MACRON

Architectural Lighting

Since 1980

# MACRON

No.352, Peng-Yi Road, Taiping, Taichung 41146, TAIWAN  
(T)+886-4-2270-8357 (F)+886-4-2277-4516  
macron@macrongroup.com

[www.macrongroup.com](http://www.macrongroup.com)